

OPERATING INSTRUCTIONS AND PARTS MANUAL

# MODEL F18/50S

## Brad Nailer

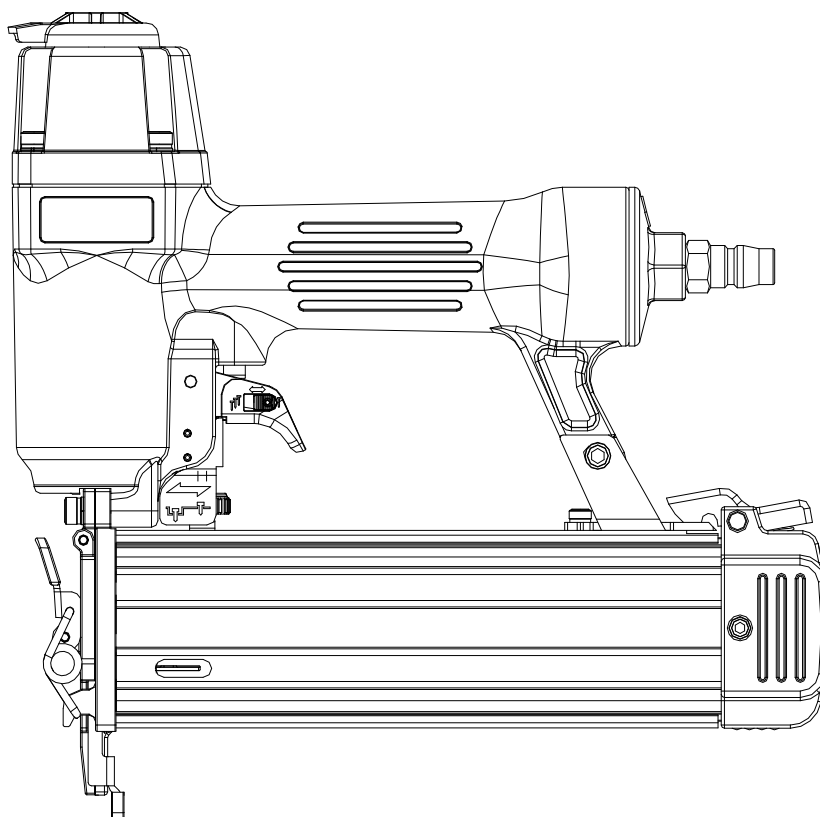

CAREFULLY READ THIS MANUAL BEFORE OPERATING TOOL

**APLUS Pneumatic Corp.**  
NO.579, SEC. 1, SHEN LIN RD., TAYA,TAICHUNG CITY 428 TAIWAN, R.O.C.  
Tel: 886-4-25602860 Fax: 886-4-25602859  
Original instructions

OPERATING INSTRUCTIONS AND PARTS MANUAL

# MODEL F18/50S

Brad Nailer

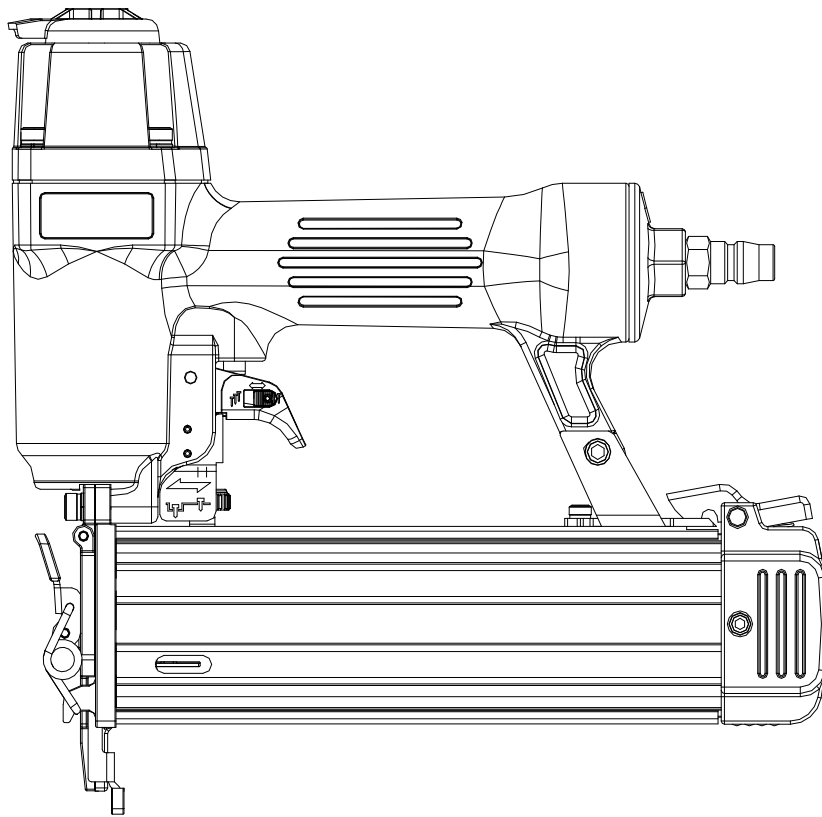

CAREFULLY READ THIS MANUAL BEFORE OPERATING TOOL

## TOOL SPECIFICATIONS

MODEL OF TOOL .....	F18/50S
TOOL LENGTH .....	10.24" (260 mm)
TOOL HEIGHT .....	9.84" (250 mm)
TOOL WIDTH .....	2.12" (54 mm)
WEIGHT (WITHOUT FASTENERS) .....	3.08 lbs (1.4 kg)
AIR INLET .....	1/4" NPT
<b>COMPRESSED AIR :</b>	
Maximum permissible operating pressure .....	110 PSIG (7.5 bar)
Recommended operating pressure range .....	60 ~ 100 PSIG (4 ~ 7bar)
AIR CONSUMPTION.....	0.0201 scfm with 25 nails per minute @ 100 psi (6.9 bar)

<b>Noise dB(A) :</b>	
A-weighted sound pressure level LpA.....	86.02 dB(A)
A-weighted sound power level LwA.....	99.02 dB(A)
Measurement uncertainty: 3dB	
<b>Vibration (m/s<sup>2</sup>) :</b>	
Hand-arm vibration value.....	2.81 m/s <sup>2</sup>
Measurement uncertainty: 1.5 m/s <sup>2</sup>	

### Warning:

The vibration emission during actual use of the power tool can differ from the declared total value depending on the ways in which the tool is used; and of the need to identify safety measures to protect the operator that are based on an estimation of exposure in the actual conditions of use (taking account of all parts of the operation cycle such as the times when the tool is switched off and when it is running idle in addition to the trigger time).

List of fasteners for F18/50S :

Crown	Thickness	Width	MAGAZINE
2.0 mm , 0.08 "	1.0 mm , 0.04 "	1.25 mm , 0.05 "	100 pcs

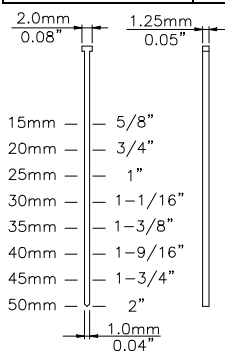

### Foreword:

This pneumatic stapler is designed for moulding, hobbies and most other jobs requiring a hammer. Its well balanced, ergonomic, comfort non-slip cushioned grip and heavy duty driving compatible staples to proper applications. Features long protruding nose to nail/staple into tight corners/groves, easy loading magazine are exactly what master needed. No more painful hammering and ensure you as satisfactory tackle and enjoy work.

### Suitable applications:

Wood and wood like applications, MDF, Hobby/Craft, fine decorative trim, beading and moulding. Tongue & Groove paneling. Cabinet and plywood assembly, garden furniture and trellis work, door/window assembly, hardwood flooring,

paneling and trim. Picture/mirror frames. Sub-flooring and many more... This electric tool is restricted to using on wood, wood like products, leather and material of paper. Any other material is forbidden.

### Caution:

Not suitable for stapling or nailing into concrete, masonry bricks or steel. Do not fire if nails are jammed, as this will cause damage to the driver blade.



Indicates an imminently hazardous situation which, if not avoided, will result in death or serious injury.

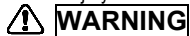

Indicates a potentially hazardous situation which, if not avoided, will result in death or serious injury.



Alerts the operator to useful information.

## SAFETY INSTRUCTIONS



1. Read this manual and understand all safety instructions before operation the tool. If you have any questions, please contact our authorized representatives.
2. Only those fasteners listed in the operating instructions may be used in the fastener driving tools.
3. Only the main energy and the lubricants listed in the operating instructions may be used.
4. Fastener driving tools marked with an inverted equilateral triangle standing on one point may only be used with an effective safety yoke.
5. Fastener driving tools equipped with contact actuation or continuous contact actuation, marked with the symbol " Do not use on scaffoldings, ladders", shall not be used for specific application for example:
  - when changing one driving location to another involves the use of scaffoldings, stairs, ladders, or ladder alike constructions, e.g. roof laths,
  - closing boxes or crates,
  - fitting transportation safety systems e.g. on vehicles and wagons.
6. For the maintenance of fastener driving tools, only spare parts specified by the manufacturer or his authorized representative shall be used.
7. Repairs shall carried out by agents authorized by the manufacturer or by other specialis-

ts, having due regard to the information given in the operating instruction.

8. Stands for mounting the fastener driving tools to a support for example a work table shall be designed and constructed by the stand manufacturer in such a way that the fastener driving tool can be safely fixed for the intended use, thus for example avoiding damage, distortion or displacement.
9. Fastener driving tools operated by compressed air shall only be connected to compressed air lines where the maximum allowable pressure cannot be exceed by a factor of more than 10%, which can for example be achieved by a pressure reduction valve which includes a downstream safety valve.
10. When using fastener driving tools operated by compressed air, particular attention must be paid to avoid exceeding the maximum allowable pressure.
11. When using fastener driving tools operated by compressed air should only be operated at the lowest pressure required for the work process at hand, in order to prevent unnecessarily high noise levels, increased wear and resulting failures.
12. Hazards caused by fire and explosion when using oxygen or combustible gases for operating compressed air operated fastener driving tools.
13. Carry the fastener driving tool at workpiece using only the handgrip, and never with the trigger actuated. Never carry the tool by the hose or pull the hose to move the tool.

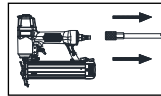

14. Disconnect the tool from air supply before cleaning jams, servicing, adjusting, and during non-operation.



15. Wear eye protection.

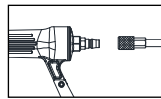

16. Do not use a check valve or any other fitting which allows air to remain in the tool.



17. Do not place your hand or any part of your body in the fastener discharge area of the tool when connecting or disconnecting air supply.



18. Never point tool at yourself or at any other person.

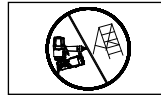

19. Do not use on scaffoldings, ladders.

## AIR SUPPLY AND CONNECTION

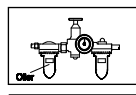

- Many air tool users find it convenient to use oiler to help provide oil circulation through tool and increase the efficiency and useful life of the tool. Check oil level in the oiler daily.

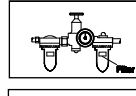

- Many air tool user find it convenient to use a filter to remove liquid and impurities which can rust or wear internal parts of the tool. A filter also increase the efficiency and useful of the tool. The filter must be checked on a daily basis and if necessary drained.

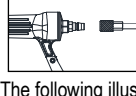

- For better performance, install a 3/8" quick connector (1/4" NPT threads) with an inside diameter of .315" on your tool and a 3/8" quick coupler on the air hose.

The following illustration shows the correct mode of connection to the air supply system which will increase the efficiency and useful life of the tool.

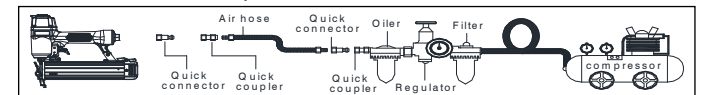

## LUBRICATION AND MAINTENANCE

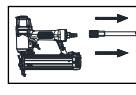

- Disconnect the air supply from the tool before lubricating.

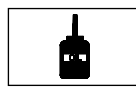

- Your tool requires lubrication before you use it for the first time.

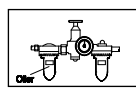

- Wipe off excessive oil at the exhaust. Excessive oil will damage O-rings of tool. If in-line oiler is used, manual lubrication through the air inlet is not required on a daily basis.

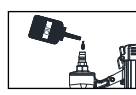

- Turn the tool so the inlet is facing up and put one drop of high speed spindle oil, UNOCAL RX22, or 3-IN-1 oil into air inlet. Never use detergent oil or additives. Operate the tool briefly after adding oil.

## LOADING THE TOOL

### WARNING



- Do not place your hand or any part of your body in the fastener discharge area of the tool when connecting or disconnecting air supply.

### WARNING



- Never point any operational fastener driving tool at yourself or at any other person.

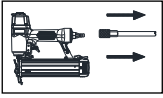

1. Disconnect air hose.

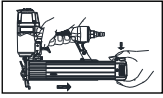

2. Depress the magazine latch. Pull back on the magazine cover.

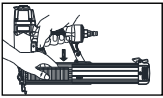

3. Insert a stick of fasteners into the magazine. Make sure the pointed ends of the fasteners are loaded with the points upward. Also make sure fasteners are not dirty or damaged.

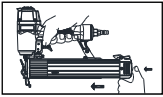

4. Push the magazine cover forward until the latch catches.

## OPERATING THE TOOL

### WARNING



Protect your eyes and ears. Wear z87.1 safety glasses with side shields. Wear hearing protection. Employers and users are responsible for ensuring the user or anyone near the tool wear this safety protection.

### NOTE



Fig.1

Check and replace any damaged or worn components on the tool. The safety warning labels on the tool must also be replaced if they are not legible.

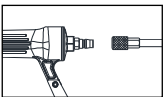

Fig.2

1. Add a few drops of UNOCAL RX22 or 3-in-1 oil into the air inlet. (See Fig. 1)

2. Attach a high flow quick connect fitting to the tool. (See Fig. 2)

3. Empty the magazine.

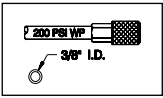

Fig.3

4. Connect the tool to an air compressor using a 3/8" I.D hose. Make sure the hose has a rated working pressure exceeding 200 PSI (13.8bar) and a female quick coupler. (See Fig. 3)

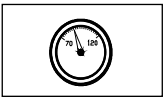

Fig.4

5. Regulate the air pressure to obtain 70 PSI (4.8 bar) at the tool. (See Fig. 4)

6. Disconnect the air supply from the tool.

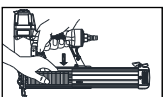

Fig.5

7. Load fasteners into your tool following the instructions in this manual. (See Fig. 5)

8. Reconnect the air supply to the tool.

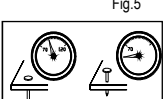
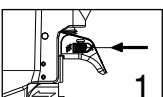
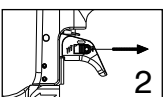

Fig.6

9. Test for proper fastener penetration by driving nails into a sample piece of wood. If the fasteners do not achieve the desired penetration, adjust the air pressure to a higher setting until the desired penetration is achieved. Do not exceed 110 PSI (7.6 bar) at the tool. (See Fig. 6)



See Fig. 1 Adjust the slide to Sequential firing.



See Fig. 2 Adjust the slide to Single firing.

## CONTACT SAFETY TRIP MECHANISM

OPERATING A CONTACT SAFETY TRIP TOOL :

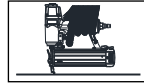

- The operator requires finger to be off the trigger and the nose of the tool to be placed on the workpiece.



- The contact safety trip mechanism is then depressed against the workpiece and the trigger is pulled to drive a fastener.

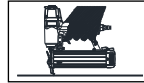

- The trigger is released after each fastener is driven.

- Move the tool to next location and the above procedure repeated.

CHECKING OPERATION OF CONTACT SAFETY TRIP MECHANISM:

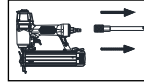

- Disconnect the air supply from the tool.

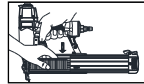

- Empty the magazine.

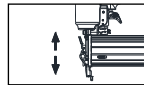

- Make sure the trigger and contact safety trip mechanism move up and down without any sticking.

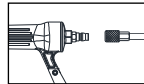

- Connect air supply to the tool.

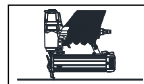

- Depress the contact safety trip mechanism against the workpiece without pulling the trigger. The tool must not cycle. Never use the tool if a cycle occurs.

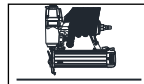

- Hold the tool clear of the workpiece. The contact safety trip mechanism should return to its original down position. Pull the trigger. The tool must not cycle. Never use the tool if a cycle occurs.

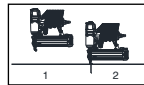

- Depress the contact safety mechanism again the workpiece and pull the trigger, the tool must cycle.

## CLEARING A JAM FROM THE TOOL

### WARNING

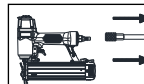

Disconnect the tool from air compressor before adjusting, clearing jams, servicing, relocating and during non-operation.

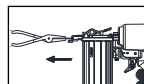

1. Fastener jammed in fastener discharge area:

- Disconnect tool from air hose.
- Grab jammed fastener with pliers and remove.



2. Fastener jam inside magazine:

- Disconnect air tool from air hose.
- Pull back on fastener pusher until locked.
- Removed jammed fastener.
- Release fastener pusher.

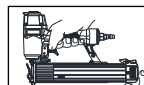

## CLEANING THE TOOL

### DANGER



Never use gasoline or other flammable liquids to clean the tool. Vapors in the tool will ignite by a spark and cause the tool to explode and result in death or serious personal injury.

### NOTE

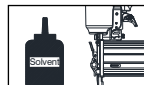

Solvents used to clean the nose of the tool and contact safety trip mechanism may soften the tar on the shingles and cause the buildup to be accelerated. Make sure to dry the tool thoroughly after cleaning and before operating the tool again.

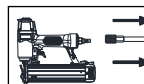

1. Disconnect the air supply from the tool.

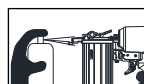

2. Remove tar buildup with kerosene #2 fuel oil or diesel fuel. Do not allow solvent to get into the cylinder or damage may occur. Dry off the tool completely before use.

# F18/50H01 (FB/S5-01)

b

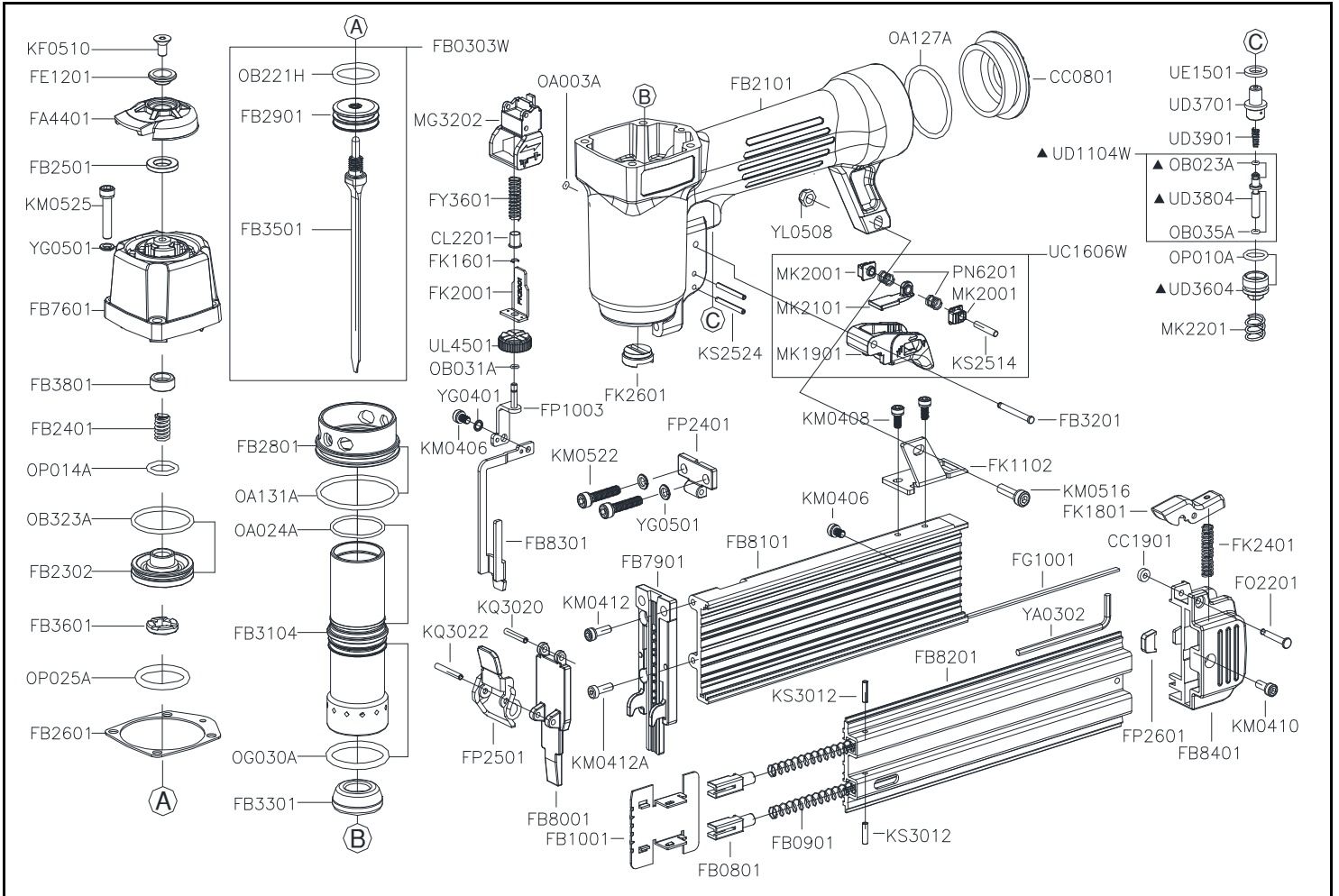

Part_No	Description	Spec	Q'ty	Part_No	Description	Spec	Q'ty	Part_No	Description	Spec	Q'ty
CC0801	END CAP		1	FK1102	SUPPORT		1	MK2201	COMPRESSION SPRING		1
CC1901	BUSHING		1	FK1601	C-RING		1	OA003A	O-RING	ARP568-003	1
CL2201	BUSHING		1	FK1801	LATCH		1	OA024A	O-RING	ARP568-024	1
FA4401	EXHAUST CAP		1	FK2001	SAFETY		1	OA127A	O-RING	ARP568-127	1
FB0303W	DRIVER ASSY.		1	FK2401	COMPRESSION SPRING		1	OA131A	O-RING	ARP568-131	1
FB0801	PUSHER PIN		2	FK2601	NOZZLE		1	▲ OB023A	O-RING	2×1.27	1
FB0901	PUSHER SPRING		2	FO2201	PIN		1	OB031A	O-RING	3×1	1
FB1001	PUSHER		1	FP1003	WORK CONTACTING ELEMENT(B)		1	OB035A	O-RING	2.9×1.2	1
FB2101	BODY		1	FP2401	ADJUSTABLE PLATE(A)		1	OB221H	O-RING	21.5×3.0	1
FB2302	HEAD VALVE PISTON		1	FP2501	FIXED PIN ASSY.		1	OB323A	O-RING	31.8×2.4	1
FB2401	COMPRESSION SPRING		1	FP2601	SAFETY CUSHION		1	OG030A	O-RING	G30	1
FB2501	PISTON STOP		1	FY3601	COMPRESSION SPRING		1	OP010A	O-RING	P10	1
FB2601	CAP SEAL		1	KF0510	FLAT HD.BOLT	M5×0.8 - 10L	1	OP014A	O-RING	P14	1
FB2801	COLLAR		1	KM0406	HEX.SOC.HD.BOLT	M4×0.7 - 6L	2	OP025A	O-RING	P25(1A)	1
FB2901	MAIN PISTON		1	KM0408	HEX.SOC.HD.BOLT	M4×0.7 - 8L	2	PN6201	COMPRESSION SPRING		2
FB3104	CYLINDER		1	KM0410	HEX.SOC.HD.BOLT	M4×0.7 - 10L	1	UC1606W	TRIGGER ASSY.		1
FB3201	PIN		1	KM0412	HEX.SOC.HD.BOLT	M4×0.7 - 12L	1	▲ UD1104W	TRIGGER VALVE ASSY.		1
FB3301	BUMPER		1	KM0412A	HEX.SOC.HD.BOLT	M4×0.7 - 12L	1	▲ UD3604	TRIGGER VALVE GUIDE		1
FB3501	DRIVER		1	KM0516	HEX.SOC.HD.BOLT	M5×0.8 - 16L	1	UD3701	TRIGGER VALVE SEAT		1
FB3601	PISTON STOP		1	KM0522	HEX.SOC.HD.BOLT	M5×0.8 - 22L	2	▲ UD3804	TRIGGER VALVE STEM		1
FB3801	PISTON STOP		1	KM0525	HEX.SOC.HD.BOLT	M5×0.8 - 25L	4	UD3901	COMPRESSION SPRING		1
FB7601	CYLINDER CAP		1	KQ3018	SPRING PIN	φ3×18L	1	UE1501	SEAL		1
FB7901	GUIDE PLATE		1	KQ3022	SPRING PIN	φ3×22L	1	UL4501	ADJUSTING WHEEL		1
FB8001	ADJUSTABLE PLATE(B)		1	KS2514	SPRING PIN	φ2.5-14L	1	YA0302	HEX BAR WRENCH	D3	1
FB8101	MAGAZINE SEAT		1	KS2524	SPRING PIN	φ2.5-24L	2	YG0401	SPRING WASHER	φ4	1
FB8201	MAGAZINE CAP		1	KS3012	SPRING PIN	φ3-12L	2	YG0501	SPRING WASHER	φ5	6
FB8301	WORK CONTACTING ELEMENT(A)		1	MG3202	SAFETY SET		1	YL0508	LOCK NUT	M5×0.8	1
FB8401	COVER		1	MK1901	TRIGGER		1				
FE1201	EXHAUST CAP RING		1	MK2001	ADJUST LUMP		2				
FG1001	BAR		1	MK2101	CONTACT LEVER		1				

★☆☆ If you need to order parts, please mark both Parts No. and Description. ☆★

2019/7/29